

## uBox universal

Base set for finish sets for standard installation

Finish: n.a. Article Number: 01001180



### Description

#### product features

- consists of: base set, siphon, pre-assembled sealing membrane, height adjustment boards, screed protection cover
- suitable for RainDrain Match, Flex, Rock and Original finish sets
- where to use: new construction, renovation
- water seal: 50 mm
- minimal installation height: 75 mm
- drainage capacity with siphon: up to 42 l/min
- drainage capacity with Dryphon: up to 60 l/min
- connection diameter: DN50
- direction of outlet: horizontal
- connection: 3-sided
- easy fixation to the floor with mounting bracket
- height adjustable with the foam boards
- mounting type: wall-mounted, free in the floor
- easy to clean siphon
- removable siphon
- suitable for soundproof mounting

### Technology



### Product image



### Scale drawing

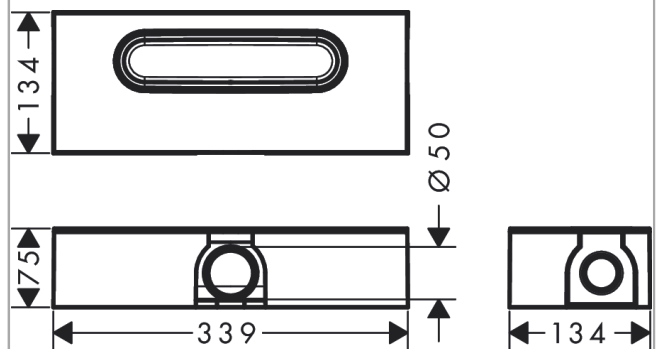

**uBox universal**  
**Base set for finish sets for standard installation**  
 Finish: n.a. Article Number: **01001180**



Exploded Drawing

Year of production: >07/21

1

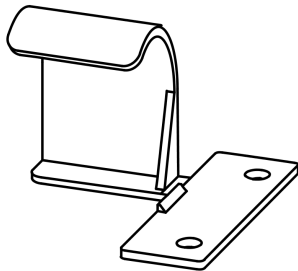

2

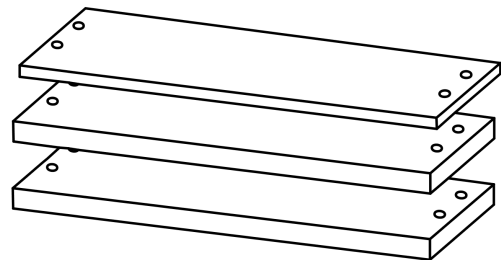

3

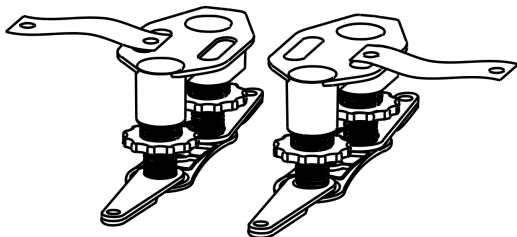

4

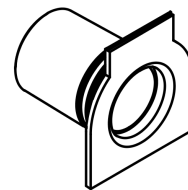

5

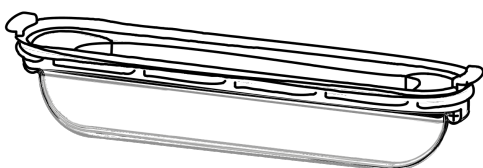

6

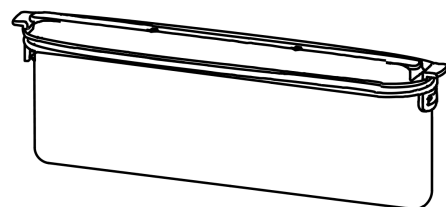

**uBox universal**  
**Base set for finish sets for standard installation**  
 Finish: n.a. Article Number: **01001180**



**Spare part list**

Year of production: >07/21

<b>Pos.</b>	<b>Description</b>	<b>Article Number</b>	<b>PC</b>	<b>PU</b>
1	mounting kit	94384000	9	1
2	compensation set	94325000	10	1
3	mounting-set	94331000	10	1
4	plug	94332000	8	1
5	Dryphon	94326000	14	1
6	trap cpl.	94323000	13	1